



TRU-FRAME®
A name you can build on.



TRU-FRAME® LEGACY Sliding Screen Door Designed For Beauty, Built To Last !

Strongest Frame Available

With a heavy-duty extruded aluminum frame that measures a full 1" x 2 1/4" x .062", it simply outclasses the competition with its unusual strength. The Legacy patio sliding door was designed to withstand the test of time.

Touch Glide Rollers

Unique, spring-loaded precision steel ball-bearing wheel assemblies have the largest range of adjustment of any door today. Specifically designed to ease installation, they prevent the door from jumping the track while allowing for a touch glide.



Auto-Latch Handle System

An all-new Color-Coded Self-Latching handle ensures the door will close correctly every time, and the locking mechanism makes sure it stays that way. The flush handle set is recessed and doesn't project into the screen area—thereby enhancing your view and eliminating screen wear.



For salt air and harsh weather conditions, an all stainless-steel wheel and housing system is now available for the Legacy patio slider. Finally, wheels that last as long as the rest of the door's components.

The Last Screen Door You'll Ever Need.



TRU-FRAME®
A name you can build on.

SLIDING SCREEN DOOR ASSEMBLED- D150



ITEM NO.	SIZE	BR (■), GR (■), WH (□)
D150##F30	31" x 81"	\$180.00
D150##F36	37" x 81"	\$187.50
D150##F48	49" x 81"	\$209.00
D150##F60	61" x 81"	\$226.50
D151##F30	31" x 96"	\$198.00
D151##F36	37" x 96"	\$207.00
D151##F48	49" x 96"	\$229.00
D151##F60	61" x 96"	\$254.50

1 - 3/4" x 1/2" x .038", Roll formed aluminum
 18 x 16 Phifer Insect Screen
 1 - Vinyl bug seal with flap and tear-off strip
 4 - Spring loaded nylon rollers with adjustment screws
 1 - Plastic locking latch and handle set (D150)
 4 - Spur corner D2061 is standard for D150
 4 - Stamped galvanized steel corner D1125 is standard for D151
 2 - Top guides
 Note: Made to order, size required (See Page 23)

Standard D150

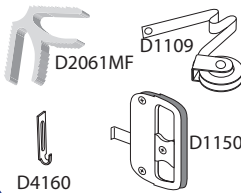

Standard D151

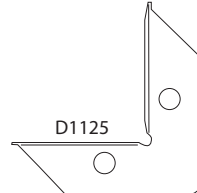

Metal Rollers \$10.00

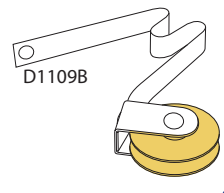

SLIDING SCREEN DOOR ASSEMBLED - D200



ITEM NO.	SIZE	BA (■)	SA (■)	##
D200##F36	37" x 81"	\$229.50	\$215.50	\$213.00
D200##F48	49" x 81"	\$265.00	\$241.00	\$233.00
D200##F60	61" x 81"	\$297.50	\$273.50	\$267.00
D200##F72	73" x 81"	\$324.50	\$293.50	\$287.50
D201##F36	37" x 96"	\$254.50	\$241.00	\$237.50
D201##F48	49" x 96"	\$298.50	\$270.00	\$257.00
D201##F60	61" x 96"	\$333.50	\$297.00	\$292.00
D201##F72	73" x 96"	\$365.50	\$333.50	\$333.50

1-7/8" x 1/2" x .050, Extruded aluminum frame (Flat Surface)
 18 x 16 Phifer Insect Screen
 4 - D2120 - Patented heavy duty die cast corners
 4 - D2140B - Spring loaded steel ball bearing rollers with screws
 1 - D2021/D2021P - Extruded aluminum handles with D2150 - lever latch housing and mortise lock
 2 - D2180 - Top guides
 1 - D2112BL (for D200) or D2111BL (for D201) - Vinyl bug seal with flap and tear-off strips
 1 - D2160 SS Strike & Screw Assembly
 Note: Made to order, size required.

Standard Handle

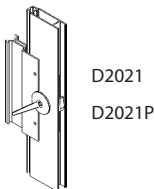

Optional Handle

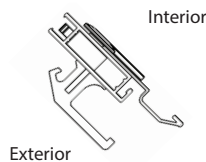

Standard Hardware

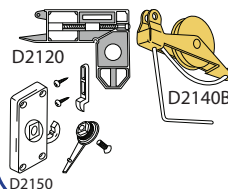

Spur Corner Metal Roller \$10.00

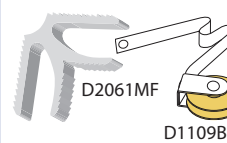

Salt Air Package \$10.00

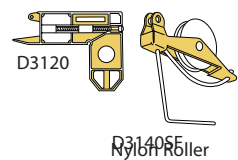

Available finishes: Bronze Anodized (■), Satin Anodized (■)
Painted Finishes: Bronze (■), Champagne Beige (■), Desert Sand (■), White (□)

SUBSTITUTIONS: Optional Hardware for each Series as depicted / Screening Options for all Sliding Screen Doors on Page 33.
NOTE: Customs cannot be cancelled or returned. The ## in the part number represents the finish. Replace ## with your choice of available finishes above. All patio doors are individually skin wrapped except for the 60". Samples are available in 16" x 32" for \$109.00 List.
PACKAGING: See [Packaging Chart](#) located in "Shipping Terms and Conditions" to calculate Packaging Fees for orders shipping Common Carrier.

Sliding Patio Door Options: See page 33 for Special Screen Options and Correct Sizing Information.



TRU-FRAME®
A name you can build on.



SLIDING SCREEN DOOR ASSEMBLED - D275

ITEM NO.	SIZE	BA	SA	##
D275##F36	37" x 81"	\$229.00	\$215.00	\$212.50
D275##F48	49" x 81"	\$265.00	\$241.50	\$236.50
D275##F60	61" x 81"	\$297.50	\$273.50	\$267.00
D275##F72	73" x 81"	\$324.50	\$293.50	\$287.00
D276##F36	37" x 96"	\$254.50	\$241.00	\$237.50
D276##F48	49" x 96"	\$298.50	\$270.00	\$257.00
D276##F60	61" x 96"	\$333.50	\$297.00	\$292.00
D276##F72	73" x 96"	\$355.00	\$333.50	\$333.00

1-7/8" x 1/2" x .050, Extruded aluminum frame (Ribbed Surface)
 18 x 16 Phifer Insect Screen
 4 - D2120 - Patented heavy duty die cast corners
 4 - D2140B - Spring loaded steel ball bearing rollers with screws
 1 - D2021/D2021P - Extruded aluminum handles with D2150 - lever latch housing and mortise lock
 2 - D2180 - Top guides
 1 - D2112BL (for D200) or D2111BL (for D201) - Vinyl bug seal with flap and tear-off strips
 1 - D2160 SS Strike & Screw Assembly
 Note: Made to order, size required

Standard Handle	Optional Handle	Standard Hardware	Spur Corner Metal Roller \$10.00	Salt Air Package \$10.00
<p>D2021 D2021P</p>	<p>Interior Exterior</p>	<p>D2120 D2150 D2140B</p>	<p>D2061MF D1109B</p>	<p>D3120 D3140SF Nylon Roller</p>

Available finishes: Bronze Anodized (■), Satin Anodized (■)
Painted Finishes: Bronze (■), Champagne Beige (■), Desert Sand (■), White (□)

SUBSTITUTIONS: Optional Hardware for each Series as depicted / Screening Options for all Sliding Screen Doors on Page 23.
NOTE: Customs cannot be cancelled or returned. The ## in the part number represents the finish. Replace ## with your choice of available finishes. All patio doors are individually skin wrapped except the 60". Samples are available in 16" x 32" for \$109.00 List.
PACKAGING: See [Packaging Chart](#) located in "Shipping Terms and Conditions" to calculate Packaging Fees for orders shipping Common Carrier.



TRU-FRAME®
A name you can build on.

PRIMACY SCREEN DOOR ASSEMBLED - D350



ITEM NO.	SIZE	SA	PAINT##
D350##F30	31" x 81"	\$279.00	\$277.00
D350##F36	37" x 81"	\$289.50	\$288.50
D350##F48	49" x 81"	\$310.50	\$307.50
D350##F60	61" x 81"	\$330.50	\$326.50
D351##F30	31" x 96"	\$318.50	\$313.00
D351##F36	37" x 96"	\$333.50	\$328.00
D351##F48	49" x 96"	\$360.50	\$351.00
D351##F60	61" x 96"	\$376.50	\$367.50

2-1/2" x 1/2" x .065, Extruded aluminum frame.
18 x 16 Phifer Insect Screen
4 - D3561MF - Heavy duty extruded aluminum Lok-Tite corners
1 - D3520/D3530 - Extruded aluminum handle w/ lever latch and mortise lock set
2 - Top guide inserts
1 - D2112BL (for D350) or D2111BL (for D351) Vinyl bug seal with flap and tear-off strip
2 - D3161 - Top Guides
2 - D1148B - 1" Steel BB rollers with flat spring (top rail installation)
2 - D1326 - 1-1/4" Steel BB adjustable rollers (bottom rail installation)
1 - D2160 SS Strike & Screw Assembly

Note: Made to order, size required

Standard Handle

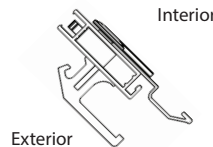

Standard Hardware



Salt Air Application \$10.00

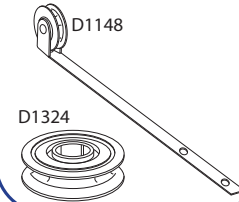

Available finishes: Satin Anodized ()

Painted Finishes: Bronze (■), Champagne Beige (■), Desert Sand (■), White (□)

LEGACY SCREEN DOOR ASSEMBLED - D500



ITEM NO.	SIZE	BA	SA	##
D500##F30	31" x 81"	\$314.00	\$300.00	\$297.50
D500##F36	37" x 81"	\$328.50	\$311.50	\$306.00
D500##F48	49" x 81"	\$358.00	\$336.00	\$330.50
D500##F60	61" x 81"	\$392.50	\$368.00	\$358.00
D501##F30	31" x 96"	\$345.50	\$330.50	\$326.50
D501##F36	37" x 96"	\$359.50	\$344.00	\$337.50
D501##F48	49" x 96"	\$378.50	\$362.50	\$358.50
D501##F60	61" x 96"	\$434.50	\$379.50	\$395.50

2-1/4" x 1" x .060 Extruded aluminum.
18 x 16 Phifer Insect Screen
4 - D5061MF - 3" Heavy duty extruded aluminum Lok-Tite corners
4 - D5120B - 1" Steel ball bearing wheel assemblies (Pre-installed)
1 - D5467 - Flush mounted aluminum die cast handle (Spring Latch)
1 - D2112BL (for D500) or D2111BL (for D501) Vinyl bug seal with flap and tear-off strip
2 - D2180 - PVC top guides
1 - D5110BL Optional Manual Latch Handle
1 - D2160 SS Strike & Screw Assembly

Note: Made to order, size required

Standard

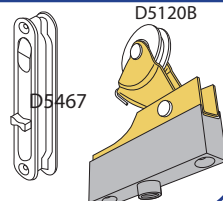

Manual Latch Hardware \$12.00

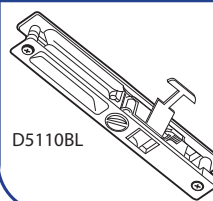

Salt Air Application \$12.00

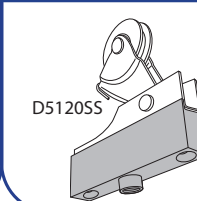

Nylon Roller \$12.00

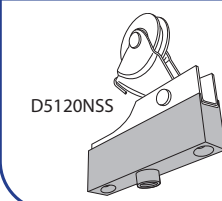

SUBSTITUTIONS: Optional Hardware for each Series as depicted / Screening Options for all Sliding Screen Doors on Page 31.

NOTE: Custom Doors can not be cancelled or returned. Doors are handed, specify XO or OX when ordering D350 & D500.

Special latch placement or roller slotting..... Add \$10.00 List

Special sizes larger than listed..... Call for quote

Sample is available in 16" x 32"..... \$141.00 List

PACKAGING: See Packaging Chart located in "Shipping Terms and Conditions" to calculate Packaging Fees for orders shipping Common Carrier.

Available finishes: Bronze Anodized (■), Satin Anodized ()

Painted Finishes: Bronze (■), Champagne Beige (■), Desert Sand (■), White (□)



TRU-FRAME®
A name you can build on.

SCREENING OPTIONS

Add the following to the LIST PRICE of any Assembled Sliding Patio Door Screen

Vision Enhancing & Aluminum	Up To 36" x 96"	Up To 48" x 96"	Up To 60" x 96"	Sun Control & Pet Control	Up To 36" x 96"	Up To 48" x 96"	Up To 60" x 96"
18 x 16 Phifer Insect	Standard	Standard	Standard	Suntex 80%	\$44.50	\$53.00	\$63.50
BetterVue if Requested	Free	Free	Free	Suntex 90%	\$53.00	\$63.50	\$74.00
UltraVue	\$32.00	\$34.50	\$37.00	Super Solar 90%	\$53.00	\$63.50	\$74.00
Brite Aluminum	\$19.00	\$23.50	\$28.50	Tuff Screen	\$37.00	\$45.00	\$53.00
Charcoal Aluminum	\$20.00	\$25.00	\$30.50	Pet Screen	\$40.50	\$50.50	\$61.00
18x14 Fiberglass Mesh	\$18.00	\$19.50	\$21.00	Brite Bronze	\$95.50	\$122.00	\$159.00
No-See-Um	\$40.00	\$47.50	\$58.50				

Measurements of actual door: W ____ " x H ____ " = NET DOOR SIZE.

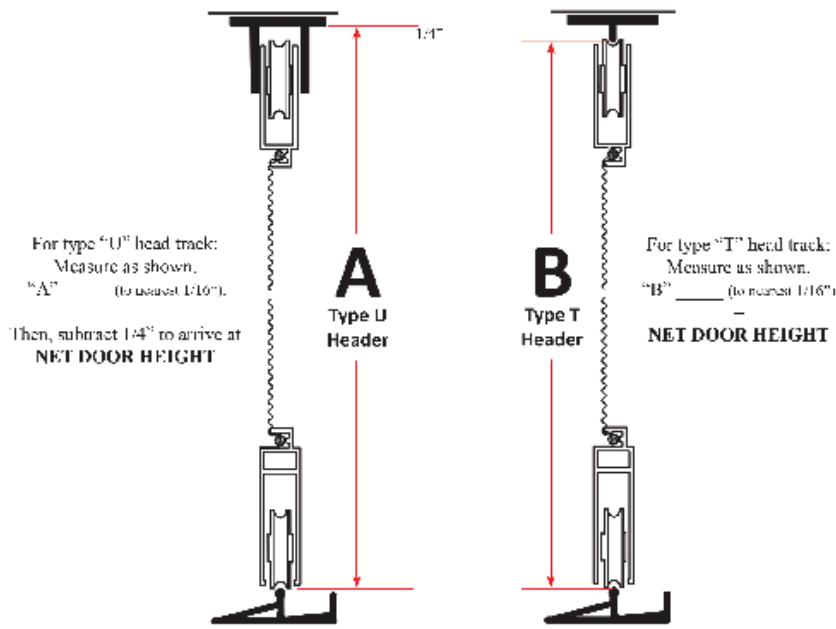

PATIO SLIDER HEIGHT:
Please use the illustration to the left as an aid in determining proper Patio Slider Screen Height

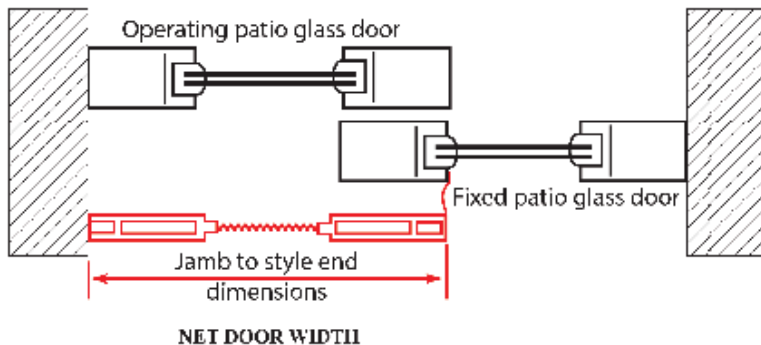

PATIO SLIDER WIDTH:
Please use the illustration to the left as an aid in determining proper Patio Slider Screen Width

Sliding Patio Door Info: Please visit our website at www.Truframe.com/catalog for additional order forms, brochures, installation instructions & more on our entire product line.



TRU-FRAME®
A name you can build on.

SLIDING SCREEN DOOR KD KIT - D150

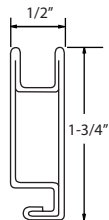

ITEM NO.	SIZE	Bronze (■), Gray (■), White (□)
D150##K30	31" x 81"	\$135.00
D150##K36	37" x 81"	\$139.00
D150##K48	49" x 81"	\$149.00
D150##K60	61" x 81"	\$162.00
D151##K30	31" x 97"	\$153.00
D151##K36	37" x 97"	\$156.50
D151##K48	49" x 97"	\$167.50
D151##K60	61" x 97"	\$182.00

Series 150 KD Kit Parts List:

- 2 - Roll Formed aluminum rails, 1-3/4" x 1/2" x 0.038 widths
- 1 - Roll Formed aluminum stile, 1-3/4" x 1/2" x 0.038", drilled at center for handle
- 1 - Roll Formed aluminum stile, 1-3/4" x 1/2" x 0.038", blank
- 4 - D2061 - Spur corner
- 4 - D1109 - Spring loaded nylon rollers with adjustment screws
- 1 - D1130 - Plastic locking latch and handle set
- 1 - D4110BL - Vinyl bug seal with flap and tear-off strip
- 2 - D4180 - Top guides

Standard Hardware

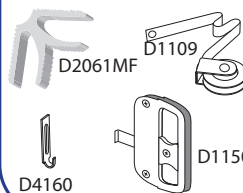

Metal Rollers \$10.00

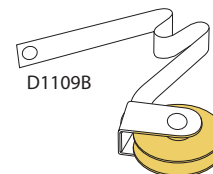

SLIDING SCREEN DOOR KD KIT - D200

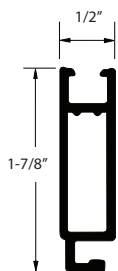

ITEM NO.	SIZE	BA	SA	##
D200##K30	32" x 81"	\$170.00	\$152.50	\$152.50
D200##K36	38" x 81"	\$176.50	\$158.00	\$158.00
D200##K48	50" x 81"	\$188.00	\$170.50	\$170.50
D200##K60	62" x 81"	\$205.00	\$182.50	\$182.50
D201##K30	32" x 97"	\$189.00	\$171.00	\$168.50
D201##K36	38" x 97"	\$198.00	\$178.50	\$172.50
D201##K48	50" x 97"	\$209.50	\$194.50	\$188.00
D201##K60	62" x 97"	\$228.00	\$205.00	\$196.50

Series 200 KD Kit Parts List:

- 2 - Extruded rails, 1-7/8" x 1/2" x .050, for widths (Flat Surface)
- 1 - Cambered extruded aluminum stile Extruded rails, 1-7/8" x 1/2" x .050, drilled for handle
- 1 - Extruded rails, 1-7/8" x 1/2" x .050, blank
- 4 - D2120 - Patented heavy duty die cast corners
- 4 - D2140B - Spring loaded steel ball bearing rollers with adjustment screws
- 1 - D2021/D2021P - Extruded aluminum handles with D2150 - lever latch housing and mortise lock set
- 2 - D2180 - Top guides
- 1 - D2112BL (for D200) or D2111BL (for D201) - Vinyl bug seal with flap and tear-off strip
- 1 - D2160 SS Strike & Screw Assembly

Standard Handle

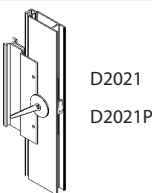

Optional Handle

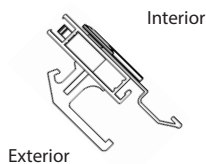

Standard Hardware

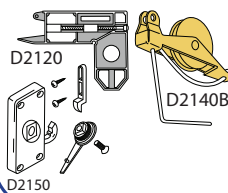

Spur Corner Metal Roller \$10.00

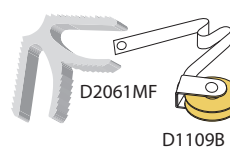

Salt Air Application \$10.00

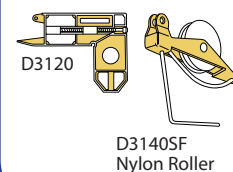

Available finishes: Bronze Anodized (■), Satin Anodized (■)
Painted Finishes: Bronze (■), Champagne Beige (■), Desert Sand (■), White (□)

NOTE: Special latch placement or roller slottingAdd \$10.00 List Each
 Special sizes - straight cut - next larger sizeAdd \$10.00 List Each
 Pre cut and mitered to size.....Add \$10.00 List Each
 Special sizes larger than listed.....Call for quote

PACKAGING: Series 150 and 200 KD Kits are packed 6 per size, per finish, per carton. Doors are priced based on full carton purchase. Size and Finishes may be combined to achieve full carton pricing. **Add \$5.00 List (per door) when purchasing in less than full carton quantities.** See Packaging Chart located in "Shipping Terms and Conditions" to calculate Packaging Fees for orders shipping Common Carrier.



TRU-FRAME®
A name you can build on.

SLIDING SCREEN DOOR KD KIT - D275

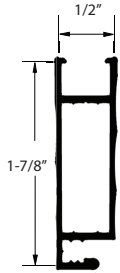

ITEM NO.	SIZE	BA	SA	##
D275##K30	32" x 81"	\$170.00	\$152.00	\$152.50
D275##K36	38" x 81"	\$176.50	\$157.50	\$157.50
D275##K48	50" x 81"	\$187.50	\$170.50	\$170.50
D275##K60	62" x 81"	\$205.00	\$182.50	\$182.50
D276##K30	32" x 97"	\$189.00	\$171.00	\$168.50
D276##K36	38" x 97"	\$197.50	\$178.00	\$172.50
D276##K48	50" x 97"	\$209.50	\$194.50	\$188.00
D276##K60	62" x 97"	\$228.00	\$205.00	\$196.50

Series 275 KD Kit Parts List:

- 2 - Extruded rails, 1-7/8" x 1/2" x .050, for widths (Ribbed Surface)
- 1 - Cambered extruded aluminum stile Extruded rails, 1-7/8" x 1/2" x .050, drilled for handle
- 1 - Extruded rails, 1-7/8" x 1/2" x .050, blank
- 4 - D2120 - Patented heavy duty die cast corners
- 4 - D2140B - Spring loaded steel ball bearing rollers with adjustment screws
- 1 - D2021/D2021P - Extruded aluminum handles with D2150 - lever latch housing and mortise lock set
- 2 - D2180 - Top guides
- 1 - D2112BL (for D200) or D2111BL (for D201) - Vinyl bug seal with flap and tear-off strip
- 1 - D2160 SS Strike & Screw Assembly

Standard Handle	Optional Handle	Standard Hardware	Spur Corner Metal Roller \$10.00	Salt Air Application \$10.00
<p>D2021 D2021P</p>	<p>Interior Exterior</p>	<p>D2120 D2150 D2140B</p>	<p>DD2061MF D1109B</p>	<p>D3120 D3140SF Nylon Roller</p>

Available finishes: Bronze Anodized (■), Satin Anodized (□)
Painted Finishes: Bronze (■), Champagne Beige (■), Desert Sand (■), White (□)

NOTE: Special latch placement or roller slottingAdd \$10.00 List Each
 Special sizes - straight cut - next larger sizeAdd \$10.00 List Each
 Pre cut and mitered to size.....Add \$10.00 List Each
 Special sizes larger than listed.....Call for quote

PACKAGING: Series 275 KD Kits are packed 6 per size, per finish, per carton. Doors are priced based on full carton purchase. Size and Finishes may be combined to achieve full carton pricing. **Add \$5.00 List (per door) when purchasing in less than full carton quantities.** See Packaging Chart located in "Shipping Terms and Conditions" to calculate Packaging Fees for orders shipping Common Carrier.



TRU-FRAME®
A name you can build on.

PRIMACY SCREEN DOOR KD KIT - D350

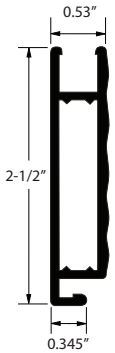

ITEM NO.	SIZE	SA	PAINT##
D350##K30	32" x 81"	\$219.50	\$215.50
D350##K36	38" x 81"	\$224.00	\$222.50
D350##K48	50" x 81"	\$238.50	\$236.50
D350##K60	62" x 81"	\$254.00	\$252.00
D351##K30	32" x 97"	\$245.50	\$247.50
D351##K36	38" x 97"	\$252.00	\$255.00
D351##K48	50" x 97"	\$258.00	\$260.00
D351##K60	62" x 97"	\$270.50	\$271.00

Series 350 KD Kit Parts List:

- 2 - Extruded aluminum rails, 2-1/2" x 1/2" x .065"
- 1 - Cambered extruded aluminum stiles, 2-1/2" x 1/2" x .065"
- 1 - D3520/D3530 - Extruded aluminum handles with D2150 - lever latch housing and mortise lock set
- 4 - D3561 MF - Heavy duty extruded aluminum Lok-Tite corners
- 2 - D3570 - Binding post with screw
- 1 - D2112BL (for D350) or D2111BL (for D351) - Vinyl bug seal with flap and tear-off strips
- 2 - D3161 - Top guides
- 2 - D1148B - 1" Steel BB rollers with flat spring (top rail installation)
- 2 - D1326 - 1-1/4" Steel BB adjustable rollers (bottom rail installation)
- 1 - D2160 SS Strike & Screw Assembly

Standard Handle

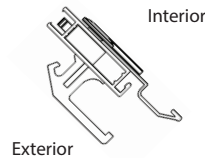

Standard Hardware

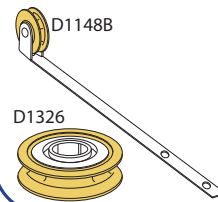

Salt Air Application \$10.00

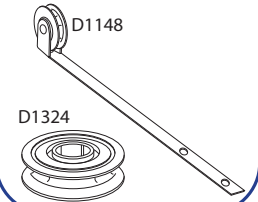

Available finishes: Satin Anodized (■)

Painted Finishes: Bronze (■), Champagne Beige (■), Desert Sand (■), White (□)

LEGACY SCREEN DOOR KD KIT- D500

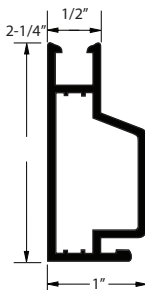

ITEM NO.	SIZE	BA	SA	##
D500##K30	32" x 81"	\$264.50	\$236.50	\$237.50
D500##K36	38" x 81"	\$272.00	\$244.00	\$242.00
D500##K48	50" x 81"	\$293.50	\$258.00	\$254.50
D500##K60	62" x 81"	\$313.50	\$277.50	\$270.00
D501##K30	32" x 97"	\$293.50	\$269.00	\$270.00
D501##K36	38" x 97"	\$303.50	\$277.50	\$278.50
D501##K48	50" x 97"	\$320.00	\$289.00	\$293.50
D501##K60	62" x 97"	\$340.50	\$308.00	\$310.00

Series 500 KD Kit Parts List:

- 2 - Extruded aluminum rails, 2-1/4" x 1/2" x .060", for widths with custom steel ball bearing wheel assemblies installed
- 1 - Cambered extruded aluminum stile, 2-1/4" x 1/2" x .060", with flush mount handle installed, XO configuration, reversible latch.
- 1 - Cambered extruded aluminum stile, 2-1/4" x 1/2" x .060", blank
- 4 - D5061 MF - Heavy duty extruded aluminum Lok-Tite corners
- 1 - D5467 - Flush mounted aluminum die cast handle (Self Latching)
- 1 - D2112BL (for D500) or D2111BL (for D501) - Vinyl bug seal with flap and tear-off strip
- 2 - Top guides
- 1 - D2160 SS Strike & Screw Assembly

Standard

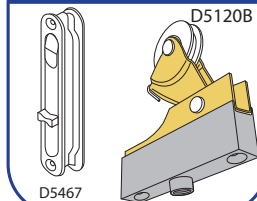

Manual Latch Hardware \$12.00

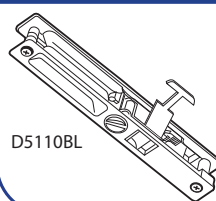

Salt Air Application \$12.00

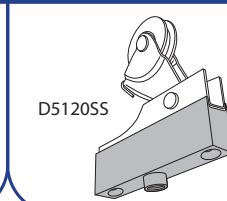

Nylon Roller \$12.00

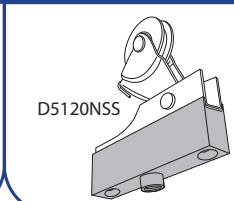

Available finishes: Bronze Anodized (■), Satin Anodized (■)

Painted Finishes: Bronze (■), Champagne Beige (■), Desert Sand (■), White (□)

NOTE:
Special latch placement or roller slottingAdd \$10.00 List Each
Special sizes - straight cut - next larger sizeAdd \$10.00 List Each
Pre cut and mitered to sizeAdd \$10.00 List Each
Special sizes larger than listedCall for quote

PACKAGING: Series 350 and 500 KD Kits are individually wrapped in plastic and priced as single units (carton pricing not required). See Packaging Chart located in "Shipping Terms and Conditions" to calculate Packaging Fees for orders shipping Common Carrier.



TRU-FRAME®
A name you can build on.



TRU-SLIDE™ - D250

ITEM NO.	SIZE	BR	SA	WH
D250##F30	30"	\$243.00	\$254.50	\$243.00
D250##F36	36"	\$252.50	\$267.00	\$252.50
D250##F48	48"	\$283.50	\$302.50	\$283.50
D250##F60	60"	\$307.50	\$328.00	\$307.50

1-7/8" x 1/2" x .050 Extruded aluminum frame
Extruded aluminum handles with lever latch housing and mortise lock set
Heavy duty extruded aluminum Lok-Tite corners
Smooth sliding steel ball bearing wheels
Vinyl bug seal with flap and tear-off strip
18 x 16 Phifer Insect Screen
Adjusts to fit opening from 78-1/2" to 81"



TRU-SLIDE™ with Pushbars - D250

ITEM NO.	SIZE	BR	SA	WH
D250##F30Y	30"	\$255.00	\$267.00	\$255.00
D250##F36Y	36"	\$265.50	\$280.50	\$265.50
D250##F48Y	48"	\$297.00	\$316.50	\$297.00
D250##F60Y	60"	\$314.00	\$339.00	\$314.00

1-7/8" x 1/2" x .050 Extruded aluminum frame
Extruded aluminum handles with lever latch housing and mortise lock set
Heavy duty extruded aluminum Lok-Tite corners
Smooth sliding steel ball bearing wheels
Vinyl bug seal with flap and tear-off strip
18 x 16 Phifer Insect Screen
Adjusts to fit opening from 78-1/2" to 81"
2 push bars

SUBSTITUTIONS: Screening Options for all Sliding Screen Doors on Page 33.

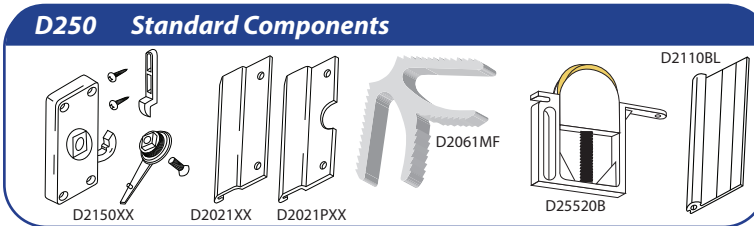



TRU-FRAME®
A name you can build on.

Item No.	Description	Length	Per Pkg	Per Piece	Per Box
EXTRUDED CHANNEL					
				List Price	
D2211SA, ##	5/8" x 1" Extruded Single Channel	144"		\$54.50	
D2221SA, ##	5/8" x 1" Extruded Double Channel	144"		\$86.50	
EXTRUDED SINGLE BOTTOM TRACK					
D2231SA, ##	Extruded Single Bottom Track	144"		\$42.50	
EXTRUDED DOUBLE BOTTOM TRACK					
D2241SA, ##	Extruded Double Bottom Track	144"		\$58.00	
D200 EXTRUDED PATIO DOOR HANDLE					
D2021SA, BA, ##	4" Extruded Patio Door Handle			\$8.50	
D200 EXTRUDED PATIO DOOR HANDLE - PUNCHED					
D2021PSA, BA, ##	4" Extruded Patio Door Handle - Punched			\$8.50	
EXTRUDED SPUR CORNER					
D2061MF	Extruded Spur Corner		25	\$4.50	\$112.50
BUG SEAL					
D2110BL	Bug Seal - Extruded Patio Door - Roll	250'		\$172.50	
D2111BL	Bug Seal - Extruded Patio Door - Strip	96"	10	\$10.50	\$105.00
D2112BL	Bug Seal - Extruded Patio Door - Strip	81"	10	\$9.50	\$95.00
D200 COMPONENTS					
D2120	Die Cast Corner with Adjustment Screw		25	\$6.00	\$150.00
D2140B	1" Steel BB Adjustable Tension Roller		25	\$6.50	\$162.50
D2150GR, BR, WH	Mortise Latch and Strike Assembly		10	\$18.50	\$185.00
D2160	Die Cast Strike & Screw Assembly		25	\$3.00	\$75.00
D2180	Top Guide Clip Green		100	\$1.50	\$150.00
D25520B	1" Tru-Slide BB Wheel Assembly		25	\$11.50	\$287.50
D200 KD KIT HARDWARE					
D24200SA, BA, ##	D200 Handle Kit Only (no roller/corner/guides)			\$21.50	
D25200SA, BA, ##	D200 KD Kit Hardware Pack (Items Incl. Below)			\$43.00	
D25200 Includes:					
4 - Die Cast Corners		4 - BB Rollers with Adjustment Screws			
1 - Set Extruded Handles		1 - Mortise Latch with Strike & Screws			
2 - Top Guides		1 - Fabrication Instruction Sheet			

Available finishes: Bronze Anodized (■), Satin Anodized (□)
 ## Painted Finishes: Bronze (■), Champagne Beige (■), Desert Sand (■), White (□)



TRU-FRAME®
A name you can build on.

Item No. Description Length Per Pkg Per Piece Per Box

D150 COMPONENTS

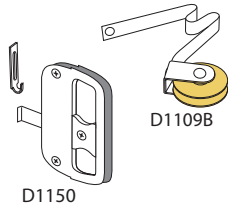

D1109	Nylon Roller WH/W Spring 1 in.		25	\$4.00	\$100.00
D1109B	Steel BB Roller WH/W Spring 1in.		25	\$5.00	\$125.00
D1130	KD Hardware Kit D150/D400		1	\$12.50	-
D1148B	5-1/4 Straight Spring RLR 1 Stl BB		10	\$7.00	\$70.00
D1150	D150 handle Assembly /550		1	\$16.00	-
D1326	Steel B.B. Roller 1-1/4 O.D.		10	\$7.00	\$70.00
D1273	T Turn Latch w/Stop and Screw Assembly		1	\$6.00	-

D350 COMPONENTS



D3570	D350 Binding Post & Screw Zinc		25	\$4.00	\$100.00
D3140SF	1 1/4" Nylon Wheel / Roller Assembly		10	\$8.00	\$80.00

D400 COMPONENTS

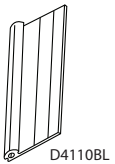

D4110BL	Vinyl Bugstrip 250ft. Black		1	\$180.00	-
D4112BL	Vinyl Bugstrip 81in. BL/25/Box		25	\$6.50	\$162.50
D4160	Replace-All Srtike 600-17J		25	\$3.25	\$81.25
D4180	Top Guide Clip-Clear		10	\$1.25	\$12.50

D500 COMPONENTS

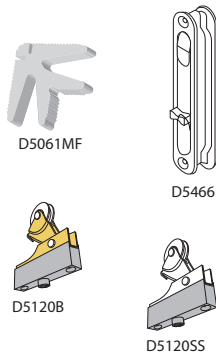

D5061MF	D500 Legacy Corner Key - Cut Pieces		25	\$9.00	\$225.00
D5120B	D500 Standard Roller Assembly		10	\$6.50	\$65.00
D5120NSP	D500 Nylon Roller Assembly		10	\$12.50	\$125.00
D5120SS	D500 Stainless Steel Roller Assembly		10	\$12.50	\$125.00
D5145	D500 Locking Latch		25	\$3.50	\$87.50
D5145SS	D500 Stainless Steel Locking Latch		25	\$4.00	\$100.00
D5466BL, WH	D500 Toggle Handle Assembly		1	\$29.00	-
D5140B	D500 Steel BB Roller only		10	\$5.00	\$50.00
D5140SS	D500 Stainless Steel Roller & Rivet		10	\$7.00	\$70.00

DISPLAYS AND HAND SAMPLES



DDS050BL	Counter Top Patio Slider Display & Sign Only		1	\$655.00	-
D150##SMPL	Series 150 Patio Door Slider Sample - 16" x 32"		1	\$100.00	-
D200##SMPL	Series 200 Patio Door Slider Sample - 16" x 32"		1	\$111.00	-
D275##SMPL	Series 275 Patio Door Slider Sample - 16" x 32"		1	\$109.00	-
D350##SMPL	Primacy D350 Patio Slider Sample - 16" x 32"		1	\$130.00	-
D500##SMPL	Legacy D500 Patio Slider Sample - 16" x 32"		1	\$141.00	-

Available finishes: Bronze Anodized (■), Satin Anodized (▨)
Painted Finishes: Bronze (■), Champagne Beige (■), Desert Sand (■), White (□)



TRU-FRAME®
A name you can build on.

Item No. Description Length Per Pkg Per Piece Per Box

EXTRUDED PATIO FRAME

List Price

D2010BA	Extruded Patio Frame	202.5"	24	\$121.00	\$2,904.00
D2010SA	Extruded Patio Frame	202.5"	24	\$111.50	\$2,676.00
D2010##	Extruded Patio Frame	202.5"	24	\$103.50	\$2,484.00
D2012BA	Extruded Patio Frame - Cambered	97"	1	\$62.50	
D2012SA	Extruded Patio Frame - Cambered	97"	1	\$50.00	
D2012##	Extruded Patio Frame - Cambered	97"	1	\$48.50	
D2013BA	Extruded Patio Frame - Cambered	81"	1	\$61.00	
D2013SA	Extruded Patio Frame - Cambered	81"	1	\$55.00	
D2013##	Extruded Patio Frame - Cambered	81"	1	\$46.50	

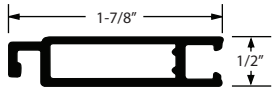

EXTRUDED PATIO FRAME - Side Rails

D2012PBA	Extruded Patio Frame - Punched - Cambered	97"	1	\$41.00	
D2012PSA	Extruded Patio Frame - Punched - Cambered	97"	1	\$61.00	
D2012P##	Extruded Patio Frame - Punched - Cambered	97"	1	\$58.50	
D2013PBA	Extruded Patio Frame - Punched - Cambered	81"	1	\$65.50	
D2013PSA	Extruded Patio Frame - Punched - Cambered	81"	1	\$61.00	
D2013P##	Extruded Patio Frame - Punched - Cambered	81"	1	\$52.00	

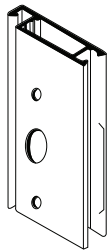

EXTRUDED PATIO FRAME - Top & Bottom Rail

D2015PBA	Extruded Patio Frame - Punched	62"	1	\$41.00	
D2015PSA	Extruded Patio Frame - Punched	62"	1	\$37.00	
D2015P##	Extruded Patio Frame - Punched	62"	1	\$35.00	
D2016PBA	Extruded Patio Frame - Punched	50"	1	\$36.00	
D2016PSA	Extruded Patio Frame - Punched	50"	1	\$33.50	
D2016P##	Extruded Patio Frame - Punched	50"	1	\$32.5	
D2017PBA	Extruded Patio Frame - Punched	38"	1	\$32.50	
D2017PSA	Extruded Patio Frame - Punched	38"	1	\$27.50	
D2017P##	Extruded Patio Frame - Punched	38"	1	\$27.50	
D2018PBA	Extruded Patio Frame - Punched	32"	1	\$27.50	
D2018PSA	Extruded Patio Frame - Punched	32"	1	\$27.50	
D2018P##	Extruded Patio Frame - Punched	32"	1	\$25.00	

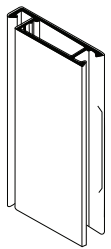

EXTRUDED PATIO ASTRAGAL

D2030BA	Extruded Patio Astragal	96"	1	\$64.00	
D2030SA	Extruded Patio Astragal	96"	1	\$58.50	
D2030##	Extruded Patio Astragal	96"	1	\$52.00	
D2031BA	Extruded Patio Astragal	84"	1	\$59.50	
D2031SA	Extruded Patio Astragal	84"	1	\$53.50	
D2031##	Extruded Patio Astragal	84"	1	\$47.50	

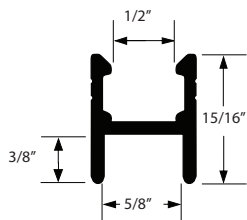

Available finishes: Bronze Anodized (■), Satin Anodized (□)
Painted Finishes: Bronze (■), Champagne Beige (■), Desert Sand (■), White (□)



ORDER / QUOTE FORM

R. Lang Company

TRU-FRAME®
A name you can build on.

ORDER QUOTE (Check One)

Sliding Patio Doors (Series D150, D200, D350)
Fax Number: 888-526-4329

DATE: _____

DEALER: _____

Completed by: _____

JOB NAME/PO#: _____

DOOR STYLE: D150 D200 D350 (circle one)

Quantity: _____ XO _____ OX _____

Frame Color: _____ (See Section D)

Net Size: _____ x _____

Fiberglass _____ Alum. _____ Other _____ (See Section F)

DOOR STYLE: D150 D200 D350 (circle one)

Quantity: _____ XO _____ OX _____

Frame Color: _____ (See Section D)

Net Size: _____ x _____

Fiberglass _____ Alum. _____ Other _____ (See Section F)

DOOR STYLE: D150 D200 D350 (circle one)

Quantity: _____ XO _____ OX _____

Frame Color: _____ (See Section D)

Net Size: _____ x _____

Fiberglass _____ Alum. _____ Other _____ (See Section F)

DOOR STYLE: D150 D200 D350 (circle one)

Quantity: _____ XO _____ OX _____

Frame Color: _____ (See Section D)

Net Size: _____ x _____

Fiberglass _____ Alum. _____ Other _____ (See Section F)

SLIDES RIGHT ↔ X	FIXED O
-------------------------------	-----------------------

FIXED O	SLIDES LEFT ← X
-----------------------	------------------------------

(Always viewed from exterior)

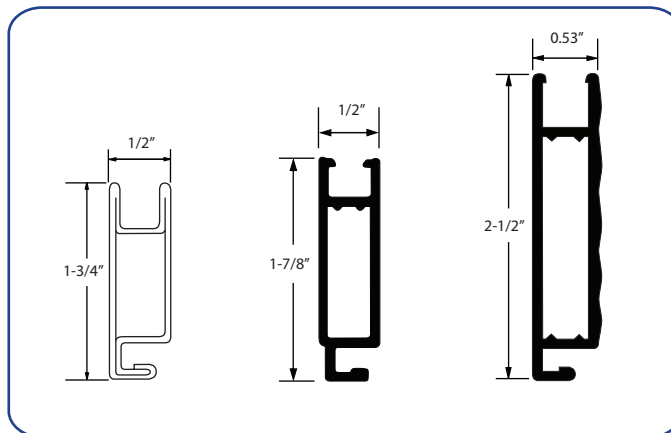



TRU-FRAME®
A name you can build on.

ORDER QUOTE (Check One)

D500 Legacy Patio Door
Fax Number: 888-526-4329

DATE: _____

DEALER: _____

Completed by: _____

JOB NAME/PO#: _____

Quantity: _____ XO ___ OX ___
 Frame Color: _____
 Net Size: _____ x _____
 Mesh Required: _____

Quantity: _____ XO ___ OX ___
 Frame Color: _____
 Net Size: _____ x _____
 Mesh Required: _____

Quantity: _____ XO ___ OX ___
 Frame Color: _____
 Net Size: _____ x _____
 Mesh Required: _____

Quantity: _____ XO ___ OX ___
 Frame Color: _____
 Net Size: _____ x _____
 Mesh Required: _____

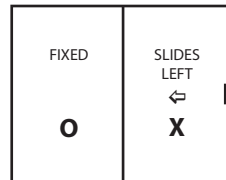
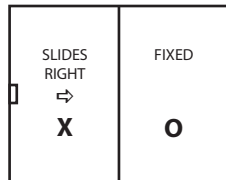

(Always viewed from exterior)

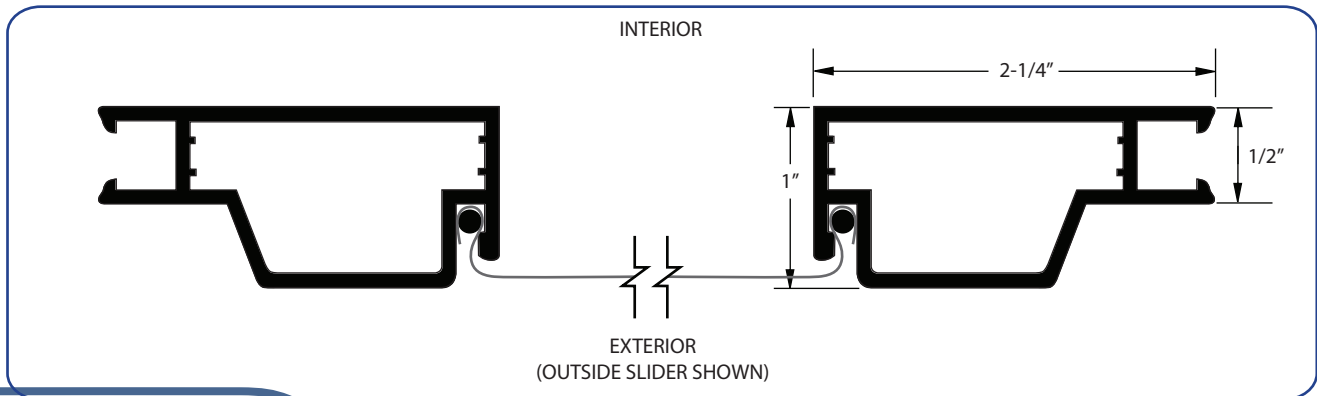

SECTION D

SECTION E